

ELITE 25

CARATTERISTICHE

Tralici in alluminio, correnti tubo Ø 50 x 2 mm e diagonali tubo Ø 16 x 1,8 mm, flange in fusione di alluminio, una combinazione vincente di estetica, prezzo e robustezza.

SISTEMA DI GIUNZIONE

Il modello Elite offre la possibilità di scegliere tra due sistemi di giunzione, per soddisfare le esigenze di molti professionisti, ed installatori.

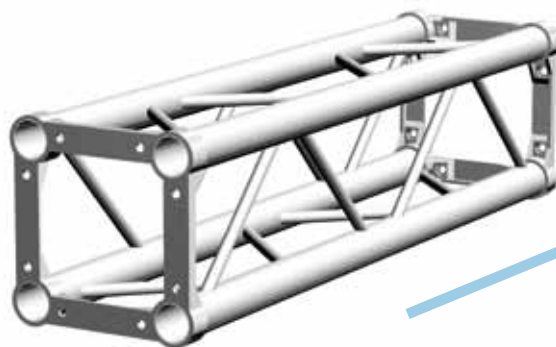

Duo

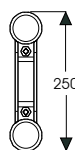

Trio

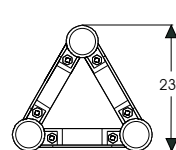

Quadro

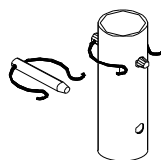
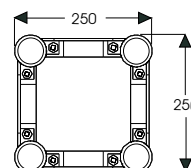

TB 5000
Set di giunzione
Elite

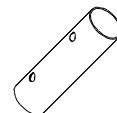

TA 6001
Giunto Standard



TA 8002
Spina innesto rapido

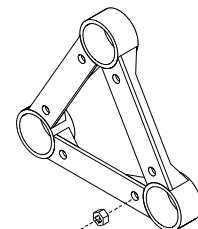

TA 6004
Set di giunzione
in dotazione

LUNGHEZZA TRALICCIO	CODICE DUO	PESO DUO	CODICE TRIO	PESO TRIO	CODICE QUADRO	PESO QUADRO
0,5 m	TB 5205	1,81 kg	TB 5305	3,20 kg	TB 5405	4,25 kg
1,0 m	TB 5210	2,93 kg	TB 5310	4,97 kg	TB 5410	6,54 kg
1,5 m	TB 5215	4,05 kg	TB 5315	6,74 kg	TB 5415	8,83 kg
2,0 m	TB 5220	5,17 kg	TB 5320	8,51 kg	TB 5420	11,12 kg
2,5 m	TB 5225	6,28 kg	TB 5325	10,27 kg	TB 5425	13,41 kg
3,0 m	TB 5230	7,40 kg	TB 5330	12,04 kg	TB 5430	15,70 kg
3,5 m	TB 5235	8,52 kg	TB 5335	13,81 kg	TB 5435	17,99 kg
4,0 m	TB 5240	9,64 kg	TB 5340	15,58 kg	TB 5440	20,28 kg

TABELLA DELLE PORTATE

LUNGHEZZA	DUO				TRIO				QUADRO			
SISTEMA DI GIUNZIONE: GIUNTO O BULLONE												
4 m	150	58	75	29	232	206	120	105	440	234	220	120
6 m	90	35	30	12	145	130	53	45	275	147	100	52
8 m	60	22	15	5	100	90	26	24	200	101	55	28
10 m	40	13	8	3	73	64	16	15	155	71	33	17
12 m	24	6	5	1	53	45	10	9	110	49	22	11
14 m	-	-	-	-	38	30	7	6	90	32	11	8
16 m	-	-	-	-	-	-	-	-	50	30	7	5