

# SQUARE CORNERS

90° CORNER 2 WAYS

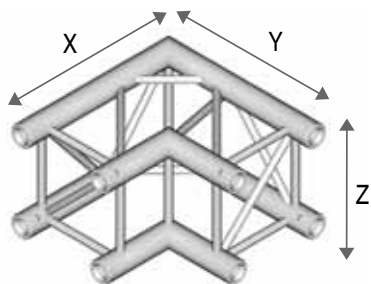

RIF. CFP

Series	Code	X	Y	Z	kg
Standard	TB 6460	400	400	250	3,98
Elite 25	TB 5460	400	400	250	4,87
Elite 30	TB 7460	450	450	300	6,20
SuperLite	TB 8460	400	400	250	5,05
Euro	TB 12460	500	500	290	6,80
Professional HD	TB 4460	450	450	300	6,40

90° CORNER 3 WAYS

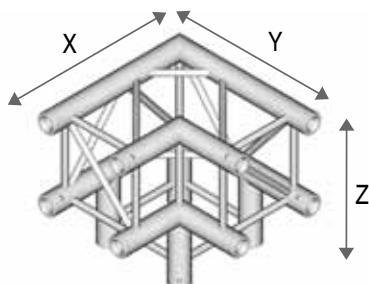

RIF. GIQS

Series	Code	X	Y	Z	kg
Standard	TB 6470	400	400	400	5,90
Elite 25	TB 5470	400	400	400	6,88
Elite 30	TB 7470	450	450	450	8,70
SuperLite	TB 8470	400	400	400	7,50
Euro	TB 12470	500	500	500	9,70
Professional HD	TB 4470	450	450	450	9,43

90° CORNER 3 WAYS "T"

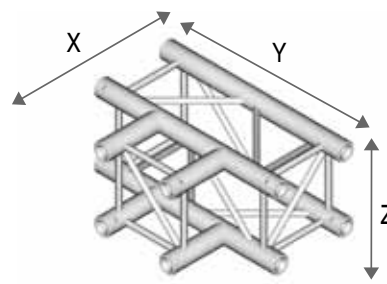

RIF. OR

Series	Code	X	Y	Z	kg
Standard	TB 6475	400	550	250	5,90
Elite 25	TB 5475	400	550	250	6,88
Elite 30	TB 7475	450	600	300	8,70
SuperLite	TB 8475	400	550	250	7,50
Euro	TB 12475	500	500	290	9,70
Professional HD	TB 4475	450	600	300	9,43

90° CORNER 4 WAYS "T"

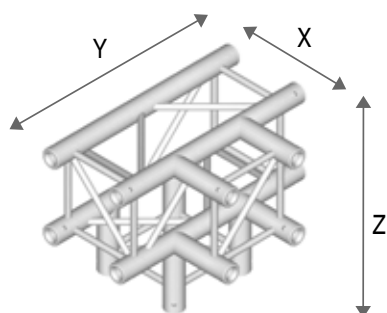

RIF. AHLD

Series	Code	X	Y	Z	kg
Standard	TB 6480	400	55	400	7,83
Elite 25	TB 5480	400	55	400	8,90
Elite 30	TB 7480	450	600	450	11,20
SuperLite	TB 8480	400	550	400	9,96
Euro	TB 12480	500	500	500	12,47
Professional HD	TB 4480	450	600	450	12,47

90° CROSS 4 WAYS

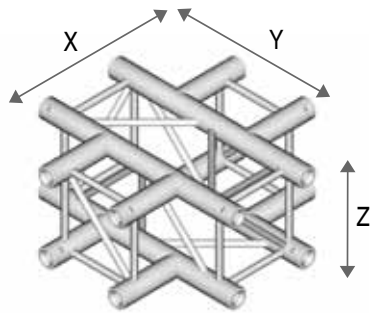

RIF. M

Series	Code	X	Y	Z	kg
Standard	TB 6485	550	550	250	7,83
Elite 25	TB 5485	550	550	250	8,90
Elite 30	TB 7485	600	600	300	11,20
SuperLite	TB 8485	550	550	250	9,96
Euro	TB 12485	500	500	290	12,47
Professional HD	TB 4485	600	600	300	12,47

90° CROSS 5 WAYS

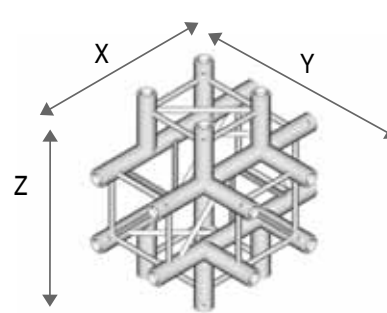

RIF. BN

Series	Code	X	Y	Z	kg
Standard	TB 6490	550	400	550	9,77
Elite 25	TB 5490	550	400	550	10,92
Elite 30	TB 7490	600	450	600	13,72
SuperLite	TB 8490	550	400	550	12,42
Euro	TB 12490	500	500	500	15,20
Professional HD	TB 4490	600	450	600	15,50

90° CROSS 6 WAYS

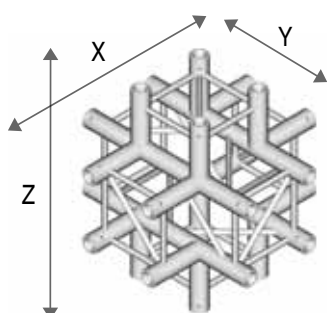

RIF. E

Series	Code	X	Y	Z	kg
Standard	TB 6495	550	550	550	11,70
Elite 25	TB 5495	550	550	550	12,94
Elite 30	TB 7495	600	600	600	16,22
SuperLite	TB 8495	550	550	550	14,78
Euro	TB 12495	500	500	500	18,15
Professional HD	TB 4495	600	600	600	18,52