

ELITE 30

GENERAL FEATURES

Aluminium truss, main tube \varnothing 50 mm x 2 mm and diagonal tube \varnothing 20 mm x 2 mm, in aluminium melted flanges. This is the perfect balance between aesthetics and strength, performance and cost.

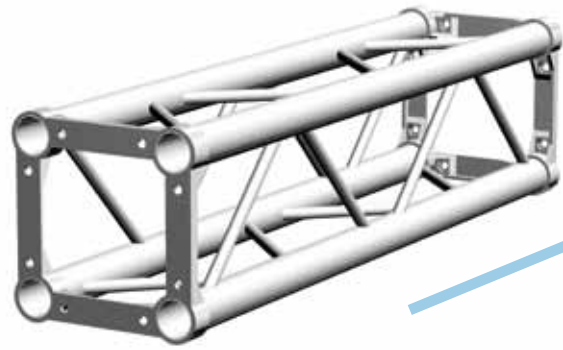

COUPLING SYSTEM

Elite model gives the user the chance to choose between two different connection systems. These meet the demands of professionals and installers.

Ladder

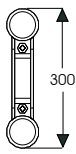

Trio

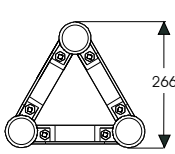

Square

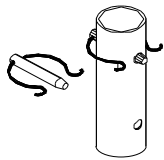
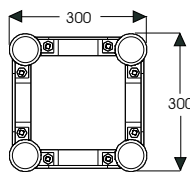

TB 5000
Elite coupling
Set

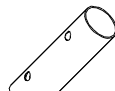

TA 6001
Standard spigot

TA 8002
Quick clip

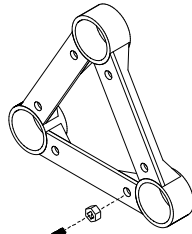

TA 6004
Coupling Set
always provided



TRUSS LENGTH	LADDER CODE	LADDER WEIGHT	TRIO CODE	TRIO WEIGHT	SQUARE CODE	SQUARE WEIGHT
0,5 m	TB 7205	2,07 kg	TB 7305	3,92 kg	TB 7405	5,22 kg
1,0 m	TB 7210	3,29 kg	TB 7310	5,95 kg	TB 7410	7,85 kg
1,5 m	TB 7215	4,50 kg	TB 7315	7,98 kg	TB 7415	10,48 kg
2,0 m	TB 7220	5,72 kg	TB 7320	10,01 kg	TB 7420	13,11 kg
2,5 m	TB 7225	6,94 kg	TB 7325	12,04 kg	TB 7425	15,74 kg
3,0 m	TB 7230	8,16 kg	TB 7330	14,07 kg	TB 7430	18,37 kg
3,5 m	TB 7235	9,37 kg	TB 7335	16,11 kg	TB 7435	20,99 kg
4,0 m	TB 7240	10,59 kg	TB 7340	18,14 kg	TB 7440	23,62 kg

TRUSS LENGTH	LADDER				TRIO				SQUARE			
	▲		▲▲▲▲		▲		▲▲▲▲		▲		▲▲▲▲	
CONNECTION SYSTEM: CONNECTOR OR BOLT												
4 m	180	76	90	38	278	251	144	128	512	311	255	157
6 m	108	47	36	16	174	161	64	54	330	198	110	67
8 m	72	31	18	8	120	113	31	29	240	139	62	36
10 m	48	20	10	4	88	82	19	17	185	101	37	21
12 m	29	12	6	2	64	60	12	11	148	74	25	13
14 m	-	-	-	-	46	43	8	7	115	54	16	9
16 m	-	-	-	-	-	-	-	-	60	48	8	6

LOADING FIGURES